

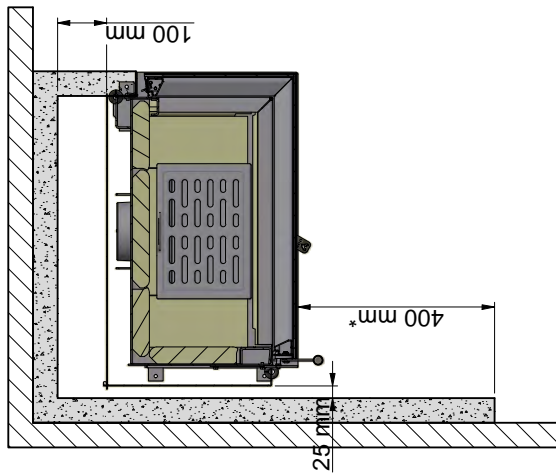

Building in the Scan 5003 with radiation shields against a flammable wall protected by a fire wall



-  Flammable material
-  Fire wall, e.g. 50 mm Jøtul Firewall, 110 mm brick or other material with corresponding fireproof and insulating abilities

All distances are in mm.
 All distances are minimum distances
 These distances apply for an insulated flue pipe all the way down to the stove
 * Distance to glass
 ** Distance to flammable floor

Installation with an insulated, vertical flue pipe
 - structure/surround to ceiling

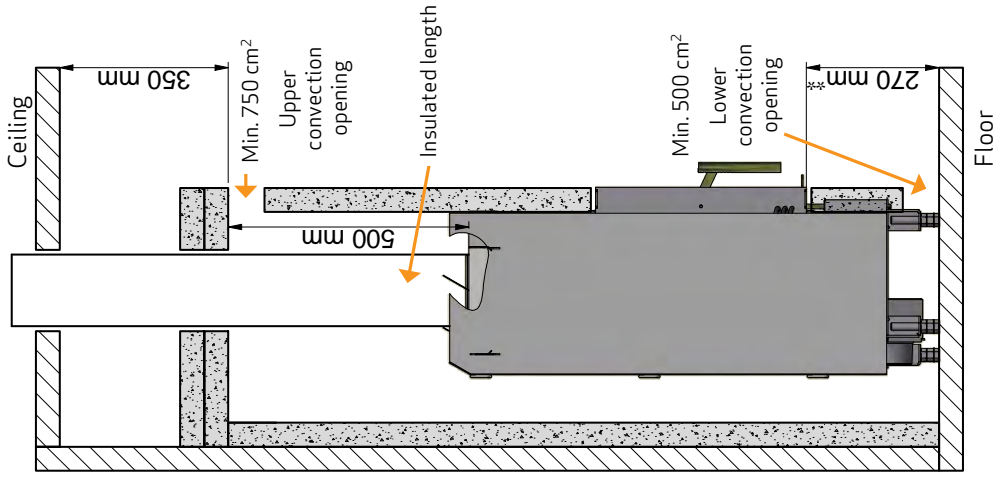

Installation with an insulated, vertical flue pipe
 - open structure/surround

