

Scan 65-1 - Scan 65-2 - Scan 65-3 - Scan 65-4

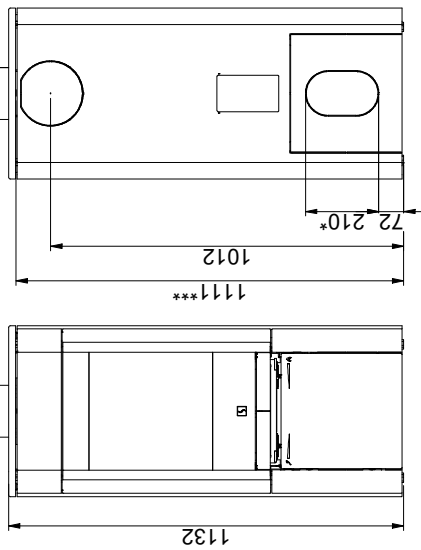

Scan 65-7 - Scan 65-8

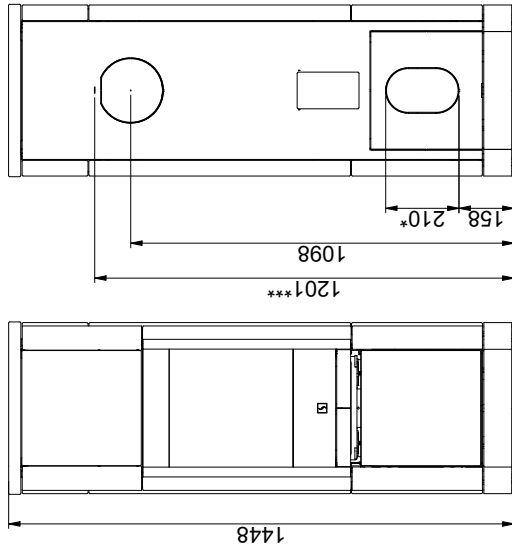

Scan 65-9 - Scan 65-10

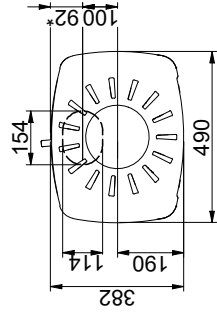
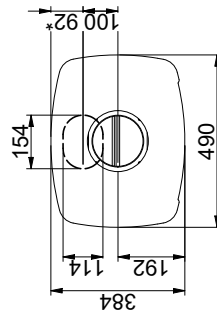
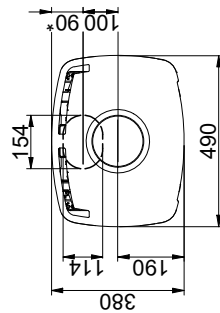
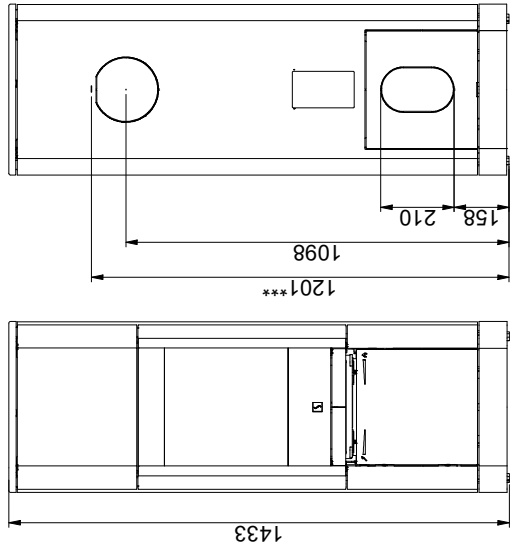

Vloerplaat

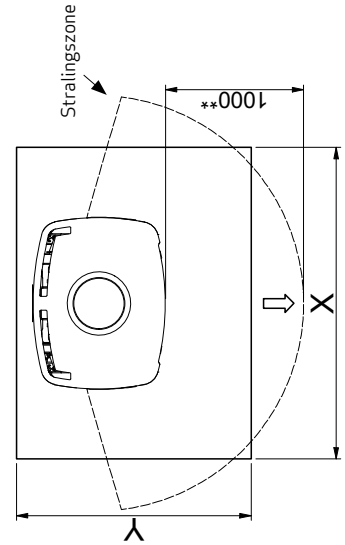

Brandbare materialen

Alle afstanden zijn in mm

Alle afstanden zijn minimumafstanden

\* Verseluchtinglaaf Ø 100 mm

\*\* Minimale afstand tot meubilair/ brandbare materialen

\*\*\* Hoogte tot begin aansluitstuk rookkanaal bij bovenaansluiting

X/Y in overeenstemming met nationale wet- en regelgeving